

86-0574-28812912

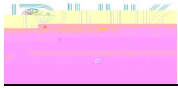

-
- -
 -
 -
 -

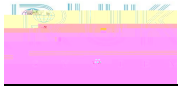



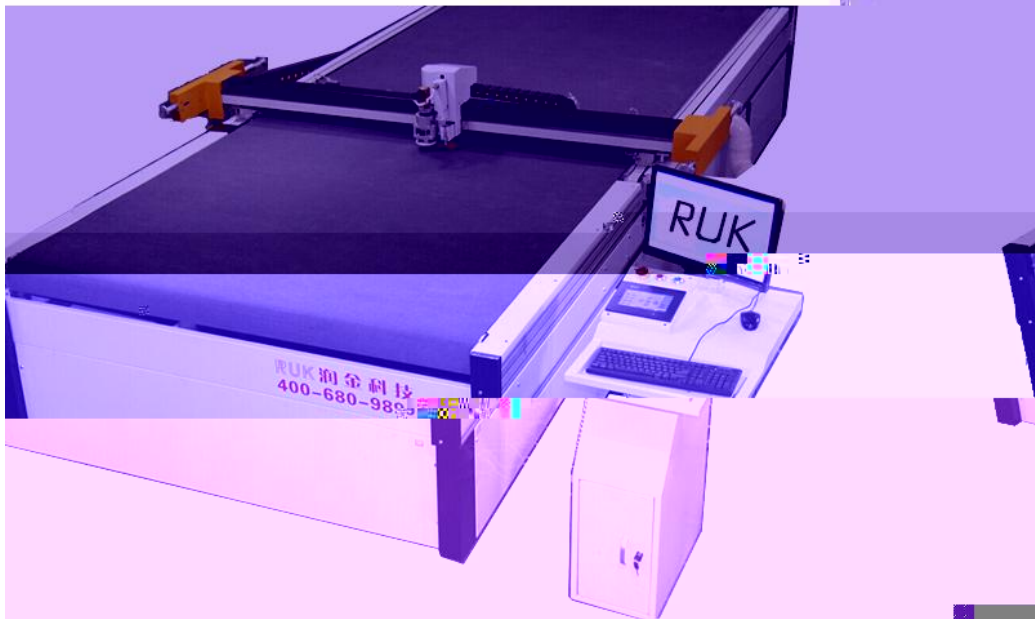
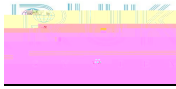

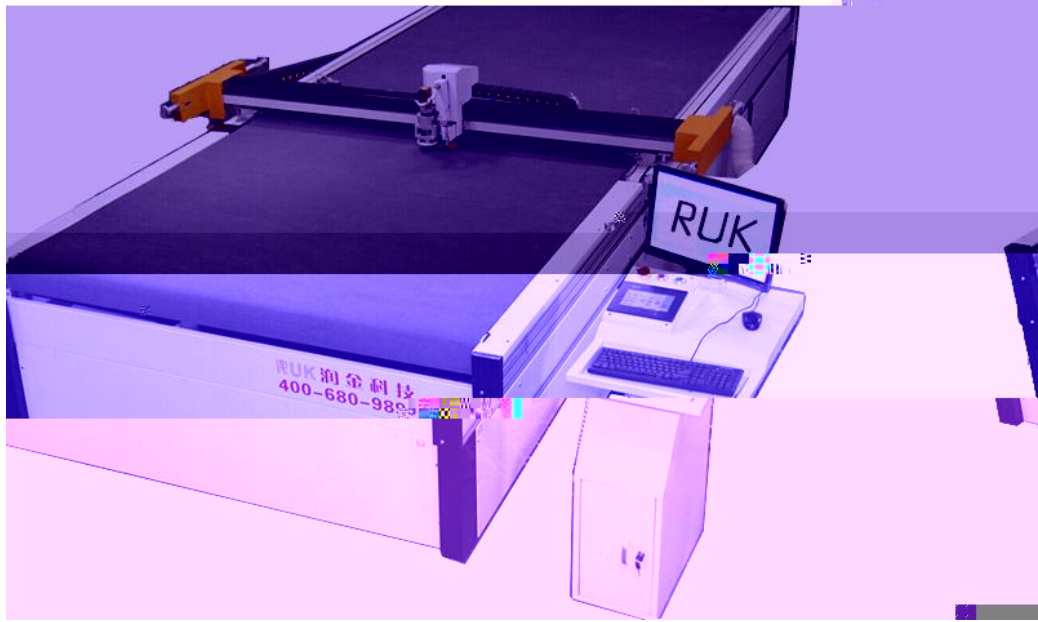
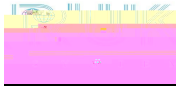

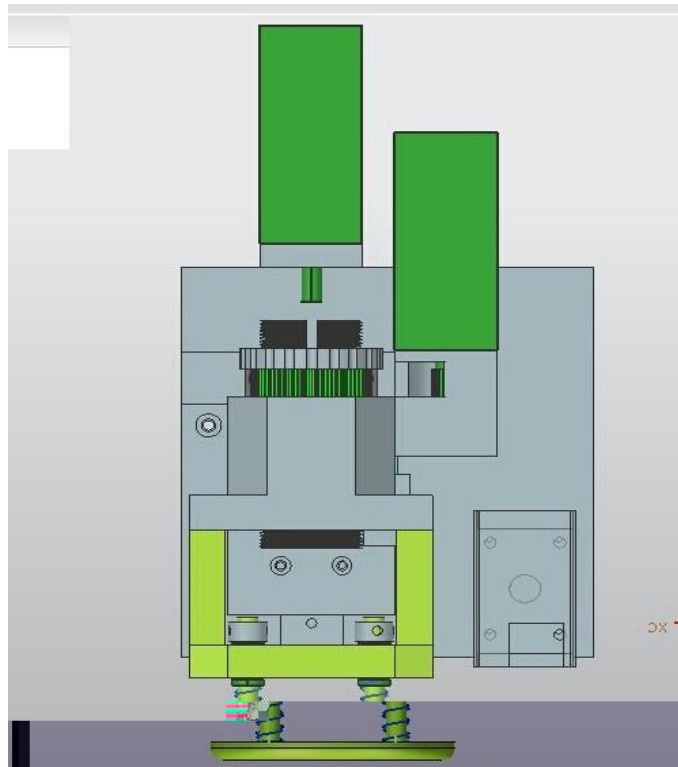
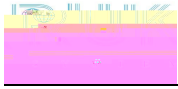

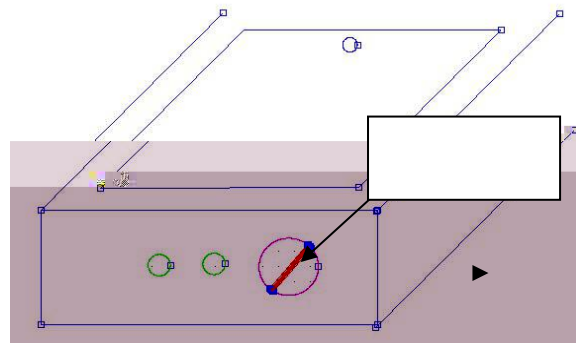
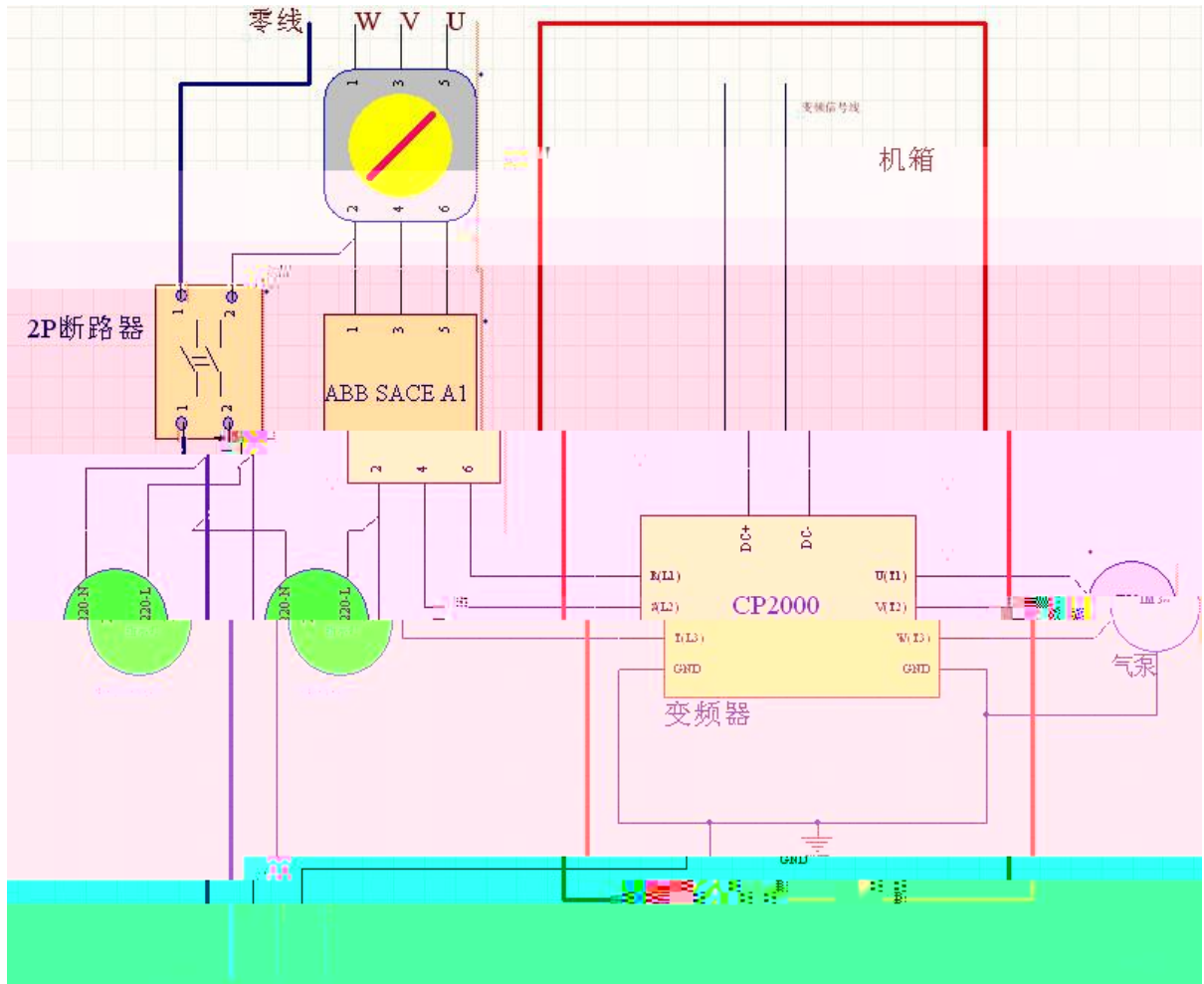
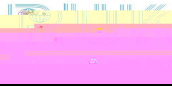

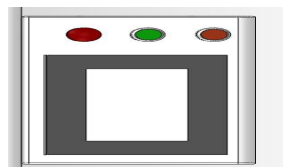
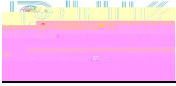

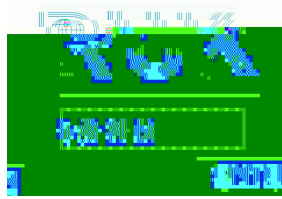
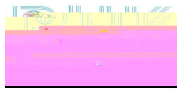

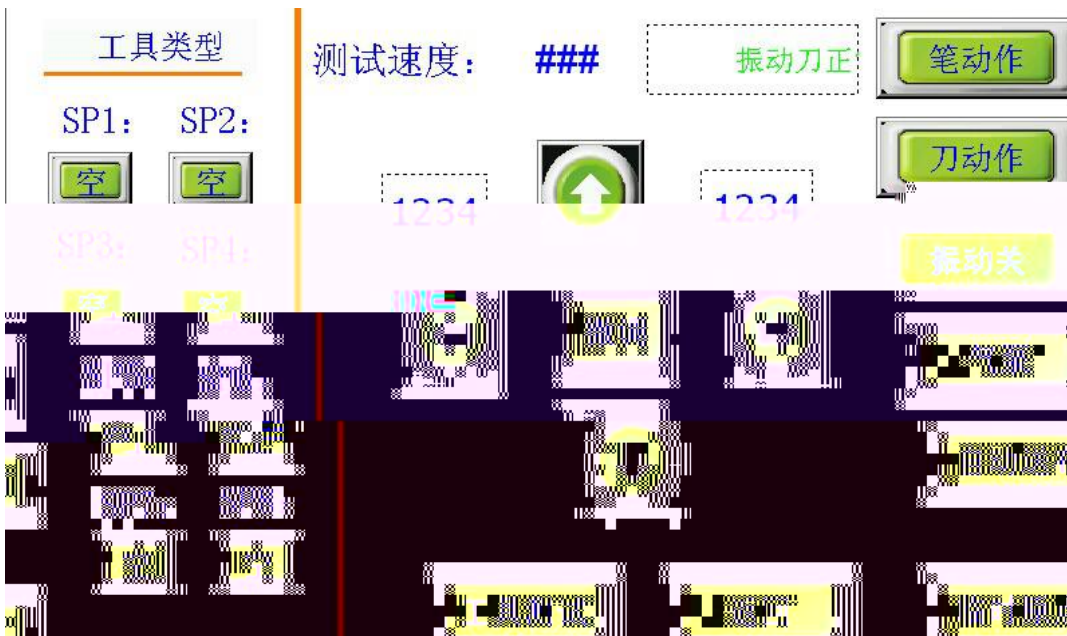
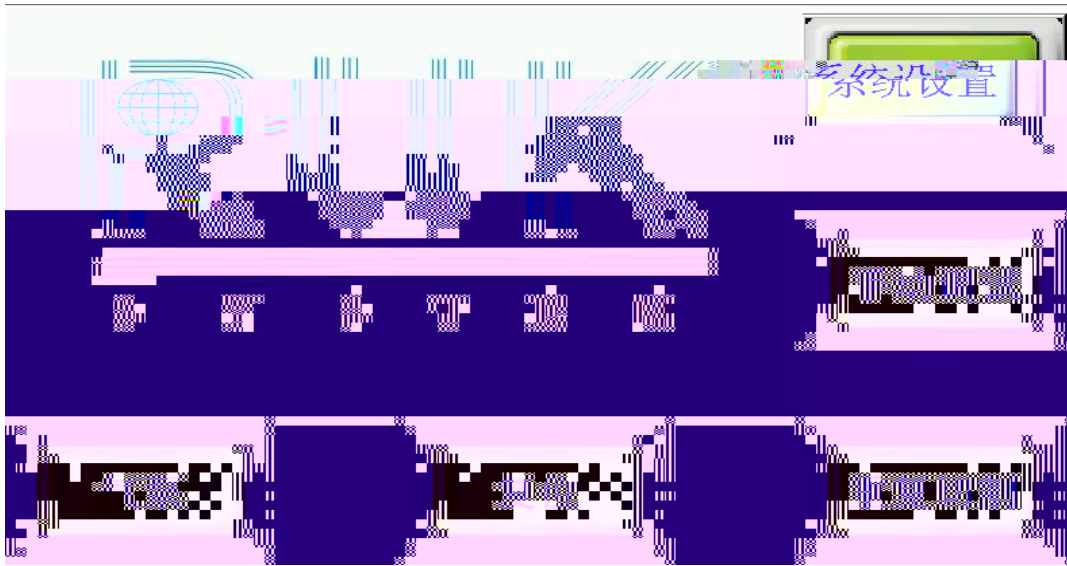
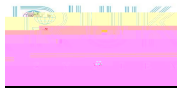



工具测试

当前位置: 123.4

中间深度: ###.#

全刀深度: ###.#

半刀深度: ###.#

振动刀正

返回 刀动作 振动关 工具参数

微调

刀深度

半刀深度

1234

1234



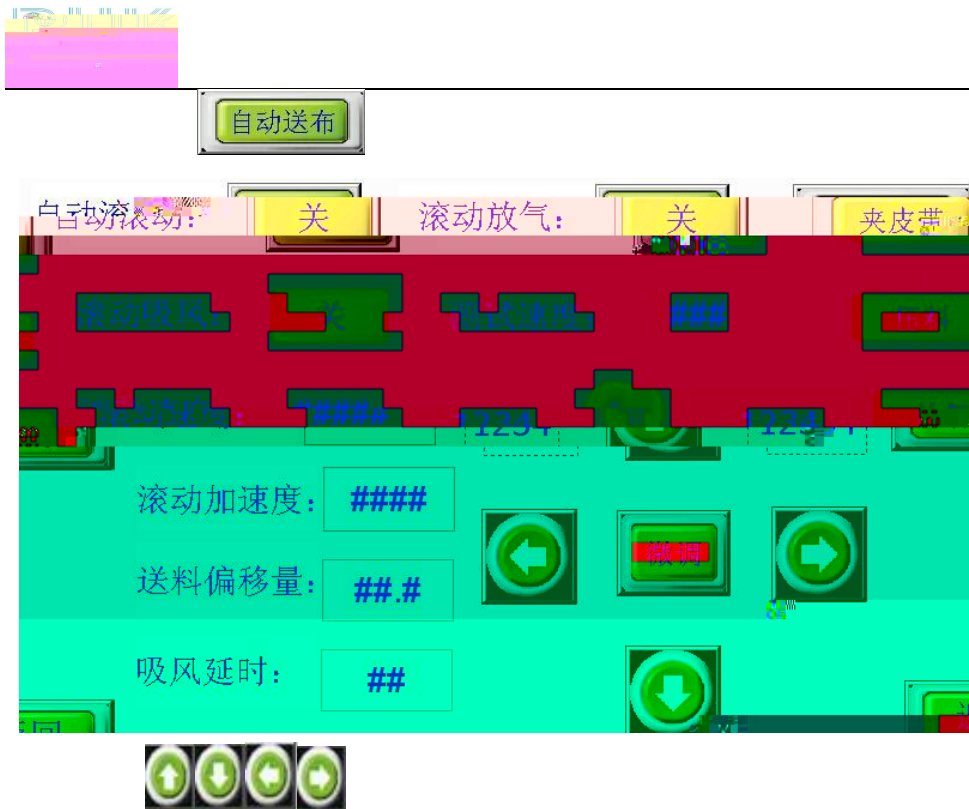

ø W'E ••

ö

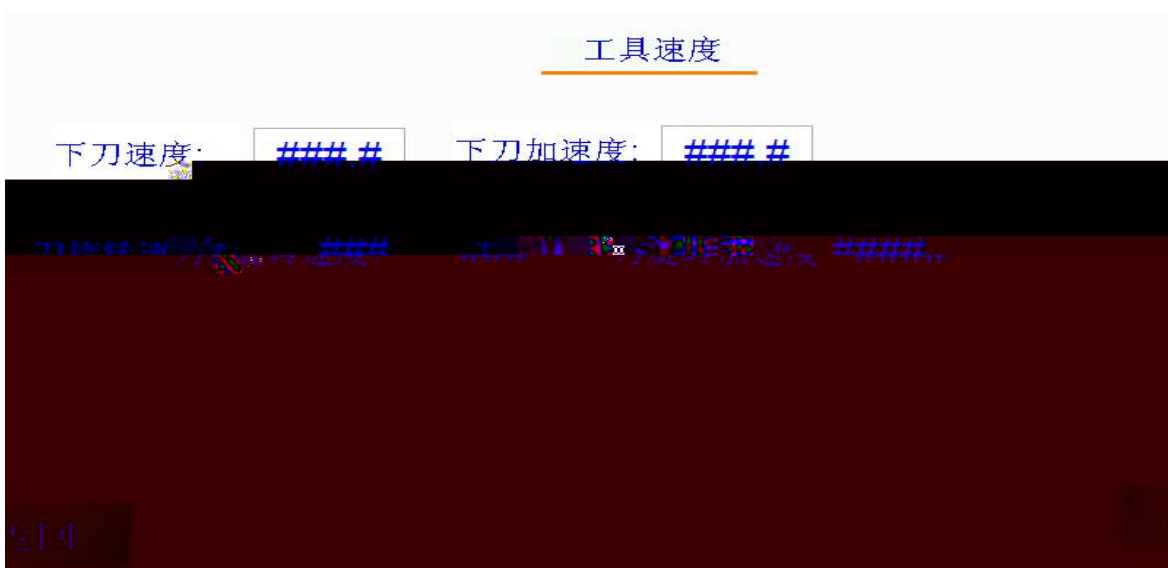

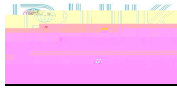

笔加速: <input type="text" value="####"/>	拾笔延迟: <input type="text" value="###"/>	刀Y轴偏移: <input type="text" value="###"/>
刀速: <input type="text" value="####"/>	下刀延迟: <input type="text" value="###"/>	旋转刀角度补偿: <input type="text" value="###"/>
刀加速: <input type="text" value="####"/>	拾刀延迟: <input type="text" value="###"/>	旋转刀冲补偿前: <input type="text" value="###"/>
空加速: <input type="text" value="####"/>	笔Y轴偏移: <input type="text" value="###.##"/>	X校正: <input type="text" value="###"/>
<input type="button" value="返回"/>	Y校正: <input type="text" value="###"/>	

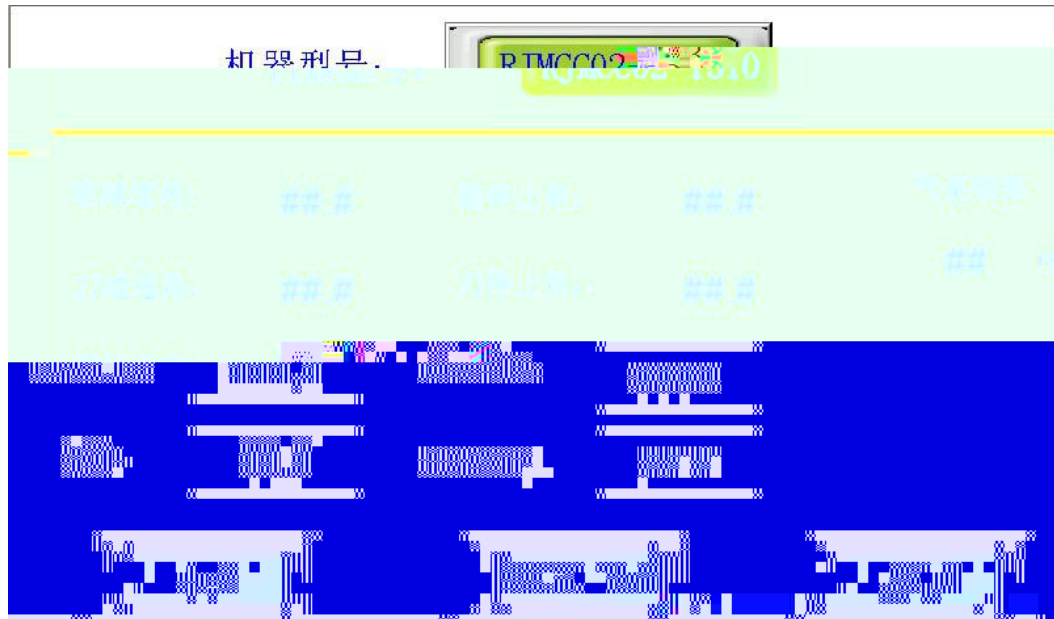
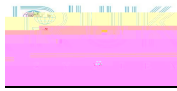



切割参数

笔速:

####

中间深度:

###.#

笔加速:

####

全刀深度:

###.#

刀速:

####

半刀深度:

###.#

刀加速:

####

空速:

####

空加速:

####

返回

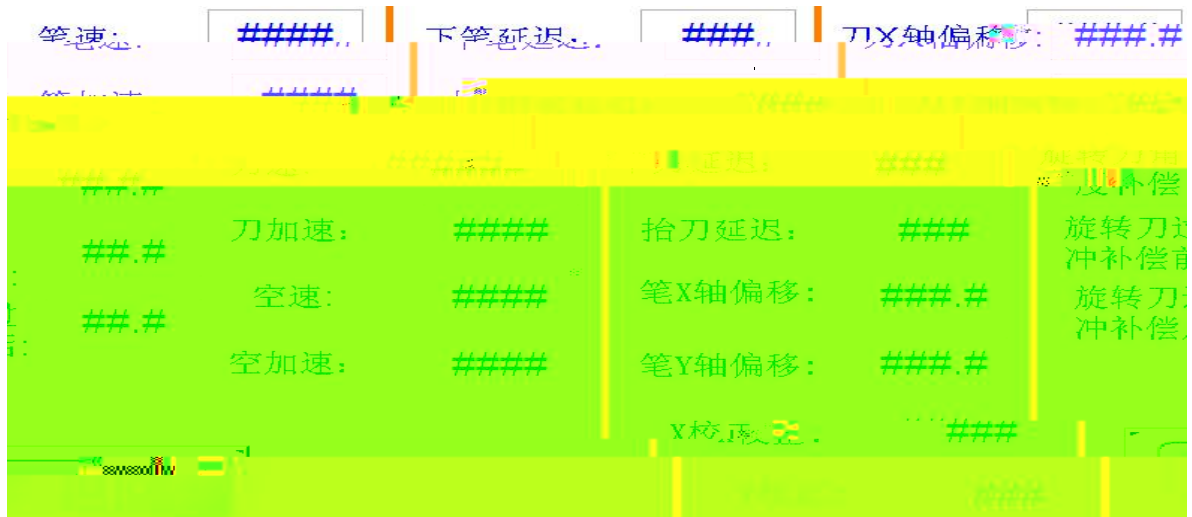
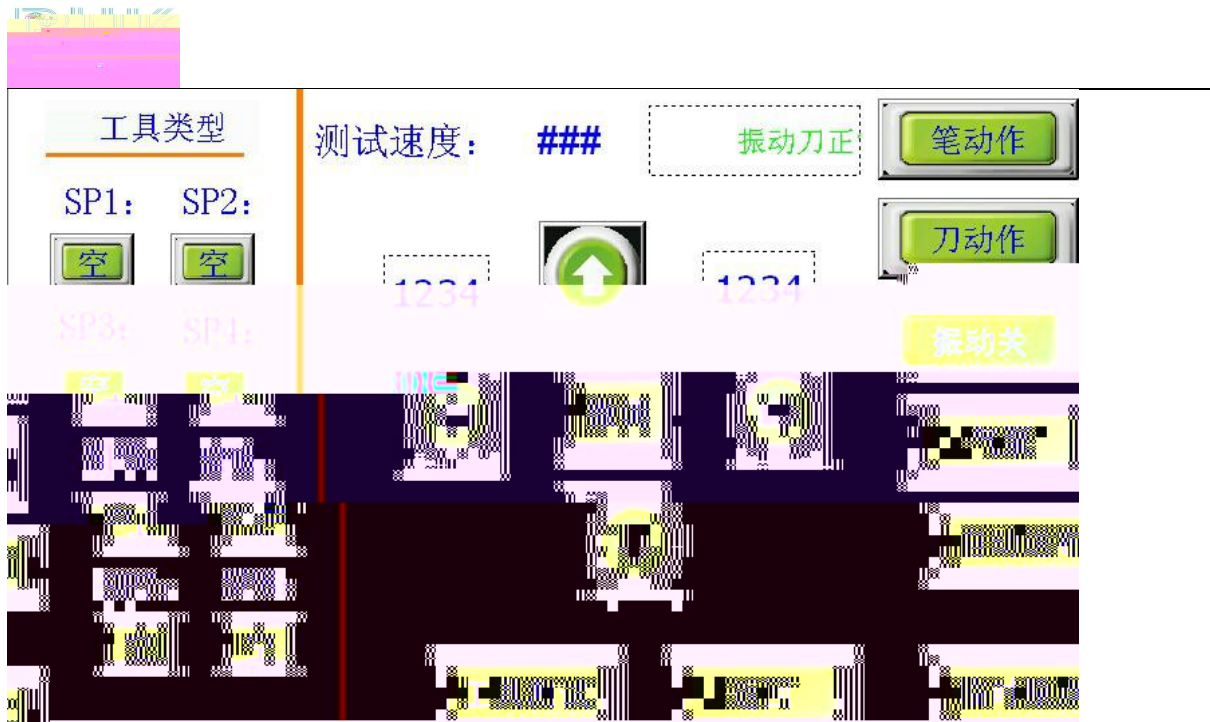

功能设置

自动重复:

关

虚线切割:

###

关

启动回原:

下载出口

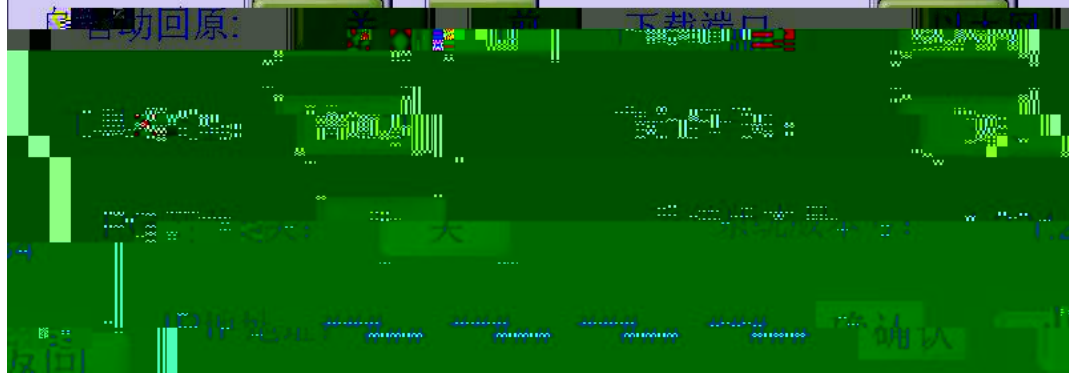

工具类型

测试速度:

###

振动刀正

笔动作

SP1: SP2:

空

空

1234



1234

刀动作

SP3: SP4:

空

空

振动关

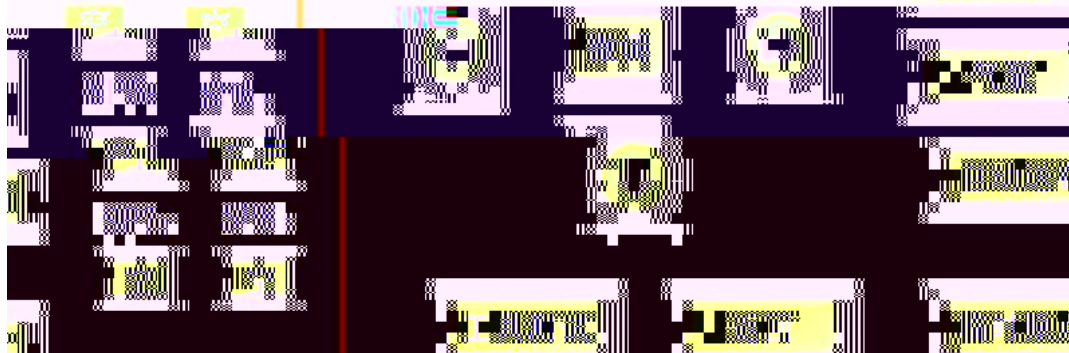

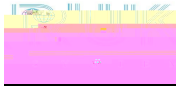

程序已过期 请联系厂家

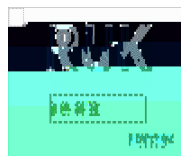

控制器编号:

剩余天数:

请输入密码:

